

Series GFT/GB

7/16", 11.11mm Center-to-Center Spacing

Current Rating: UL and CSA: 20 amps

Voltage Rating:

CSA – 300 volts

UL – *150 volts – General Industrial

250 volts – Commercial Applications

300 volts – Limited Energy Applications

**600 volts – Limited Energy Applications

* GFT, GFTP, GFTS, GFTAL rated for 300 volts.

** GFT, GFTP, GFTS, GFTAL rated for 600 volts.

Breakdown Voltage:	GFT	GB
Terminal - Terminal	3,600V Typ.	5,000V Typ.
Terminal - Ground	5,800V Typ.	7,900V Typ.

 Recognized under the Components Program of Underwriters Laboratories, Inc. Standard 1059, Guide No. XCFR2, File No. E62557.

 Guide No. 22.2 No. 158, Report No. LR39186-1.

No. of Terminals: 1 through 26

Wire Range: No. 22AWG to No. 12AWG (CSA requires use of lugs on wire larger than No. 16AWG.)

Tightening Torque:

Wire Binding Screw 9 in.-lb.

Wire Clamp 9 in.-lb.

Housing:

	standard	"x" grade
Material	Phenolic	Polyphenylene oxide
Continuous Use Temp (UL Index)	150°C (302°F)	110°C (230°F)
Flammability Rating	UL 94 HB	UL 94V-0

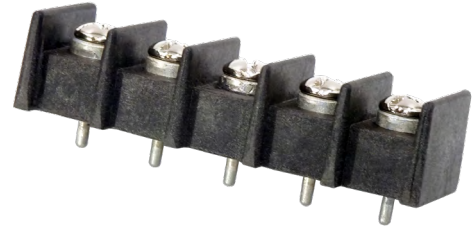

Features:

- **Superior Construction** – All terminals are molded in place with precision screw machined brass inserts.
- **Ideal for Sub-Chassis or Thru-Panel Application** – Feature provides a full 1/4" terminal to ground clearance even through 1/16" chassis.
- **Durable Base Material** – Made of black thermo-set phenolic break-resistant thermoplastic.
- **Feed-Thru, Printed Circuit or Surface Connection.**
- **Terminal Flexibility** – External terminals available in two screw sizes with various internal terminal types.
- **Recognition and Listing** – UL recognized and CSA certified.

Mechanical Drawing

Series GFT/GB with Mounting Ends

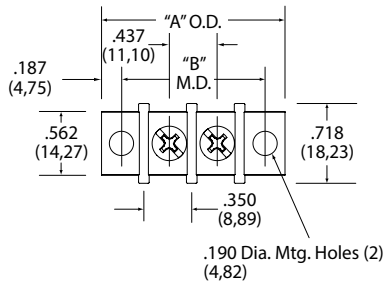

Dimensions shown are $\pm 0.030''$

Series GFT/GB Variations

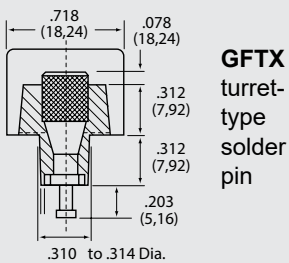

GFTX
turret-type
solder
pin

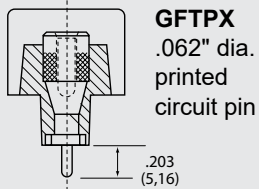

GFTPX
.062" dia.
printed
circuit pin

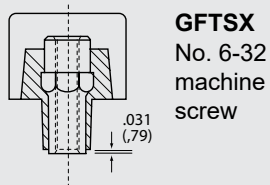

GFTSX
No. 6-32
machine
screw

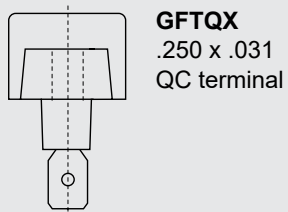

GFTQX
.250 x .031
QC terminal

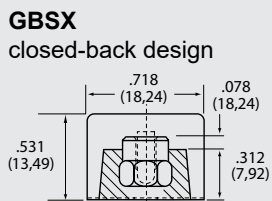

GBSX
closed-back design

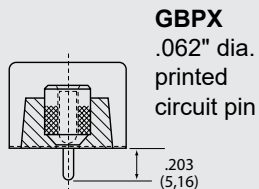

GBPX
.062" dia.
printed
circuit pin

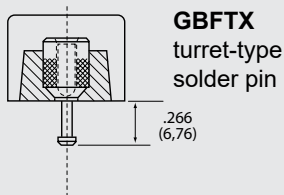

GBFTX
turret-type
solder pin

Number of Terminals	Series GFT/GB With Mounting Ends				Without Mounting Ends	
	Dimensions					
	B $\pm .031$ Mounting Dimensions (M.D.)		A $\pm .031$ Overall Dimensions (O.D.)		C $\pm .031$ Less Mounting Positions	
	Inches	Metric (mm)	Inches	Metric (mm)	Inches	Metric (mm)
1	.875	22.22	1.250	31.75	.562	14.28
2	1.312	33.33	1.687	42.86	1.000	25.40
3	1.750	44.45	2.125	53.97	1.437	36.51
4	2.187	55.56	2.562	65.08	1.875	47.62
5	2.625	66.67	3.000	76.20	2.312	58.73
6	3.062	77.78	3.437	87.31	2.750	69.85
7	3.500	88.90	3.875	98.42	3.187	80.96
8	3.937	100.01	4.312	109.53	3.625	92.07
9	4.375	111.12	4.750	120.65	4.062	103.18
10	4.812	122.23	5.187	131.76	4.500	114.30
11	5.250	133.35	5.625	142.87	4.937	125.41
12	5.687	144.46	6.062	153.98	5.375	136.52
13	6.125	155.57	6.500	165.10	5.812	147.63
14	6.562	166.68	6.937	176.21	6.250	158.75
15	7.000	177.80	7.375	187.32	6.687	169.86
16	7.437	188.91	7.812	198.43	7.125	180.97
17	7.875	200.02	8.250	209.55	7.562	192.08
18	8.312	211.13	8.687	220.66	8.000	203.20
19	8.750	222.25	9.125	231.77	8.437	214.31
20	9.187	233.36	9.562	242.88	8.875	225.42
21	9.625	244.47	10.000	254.00	9.312	236.53
22	10.062	255.58	10.437	265.11	9.750	247.65
23	10.500	266.70	10.875	276.22	10.187	258.76
24	10.937	277.81	11.312	287.33	10.625	269.87
25	11.375	288.92	11.750	298.45	11.062	280.98
26	11.812	300.03	12.187	309.56	11.500	292.10

Dimensions shown are $\pm 0.030''$

PC BOARD DRILLING DIMENSIONS

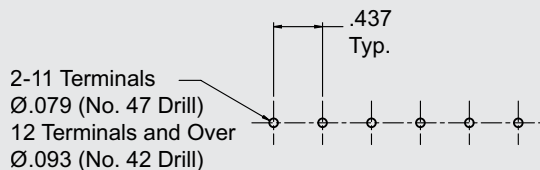

Part Number

How to Order

GB/GFT Series terminal blocks are ordered by listing a composite number made up of the model designation followed by the number of poles required for the application. Example: Type GBP 10-pole block becomes stock number GBP-10.

Suffixes are used as follows:

- A denotes model with No. 8-32 external screw terminal
- C denotes model less mounting positions
- X denotes model with thermoplastic molding

To specify quick-connect terminals, simply add the style number required. May be purchased factory-assembled or as customer-installed accessory.

The GBP-10 described above – made from thermo-set phenolic – less mounting positions thus converts to stock number GBPC-10.

INTERNAL TERMINAL DESIGNATIONS

GFTP	Printed circuit board design with .062" dia. tin-plated brass turret-type solder pin
GFT	Tin-plated brass turret-type solder pin
GFTS	Unplated brass insert. No. 6-32 plated steel screw.
GBS	Unplated brass insert. Closed-back design which can be mounted on metal surface with no additional insulation required.
GBP	Printed circuit board design with .062" dia. tin plated brass pin.
GBFT	Tin-plated brass turret-type solder pin.
GFTQX	.250 x .031 tin-plated brass quick connect tab terminal.

EXTERNAL TERMINAL DESIGNATIONS

GBFT, GBP,	Screw terminal with No. 6-32 plated steel*
GBS, GFT, GFTP	Screw accepting up to No. 12AWG wire
GBFTA, GBPA,	Screw terminal with No. 8-32
GBSA, GFTA,	plated steel* screw accepting up to
GFTSA, GFTPA	No. 12AWG wire

* Other materials may be available – contact Curtis sales or your local representative for additional information.

Quick-Connect Terminals

Series GFT/GB Accessories

QUICK-CONNECT TERMINALS

GFT-GFT – Available with .250" x .032" quick-connect tabs of tin-plated brass, held in place by terminal screws. Six styles, one to six terminations per pole. Factory-assembled or customer installed.

Quick connect terminals rated for 125V commercial appliance applications only.

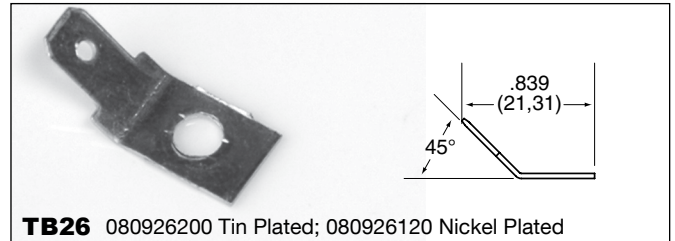
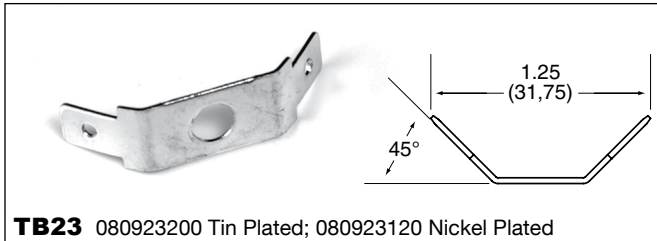
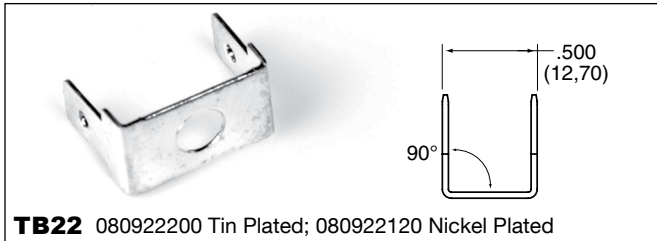
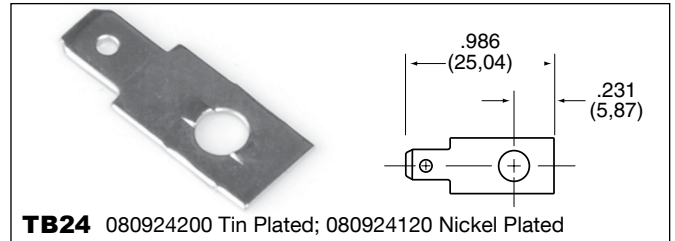
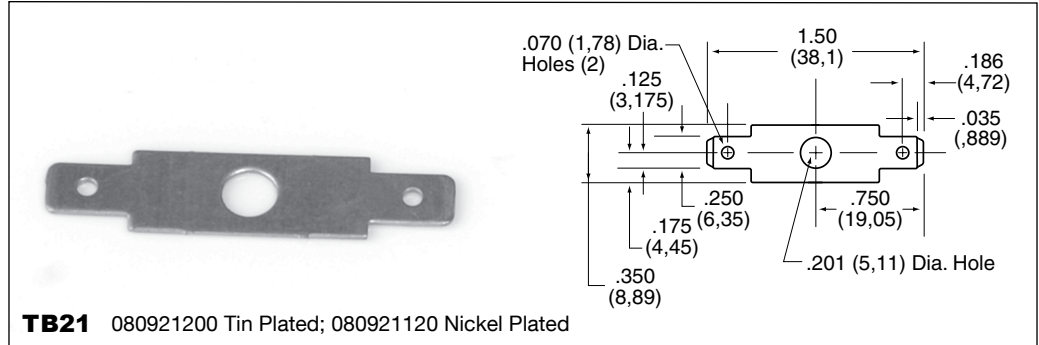

Accessories

TINNERMAN NUT

GFT – for speed mounting of terminal blocks less mounting position.
Part No. TN-437 (062600000).

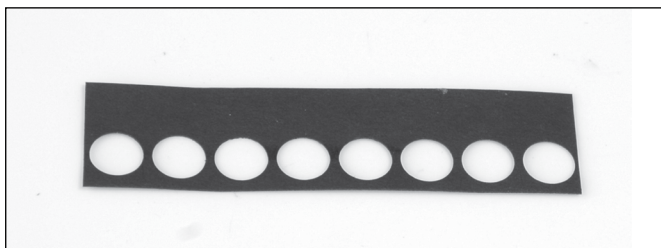
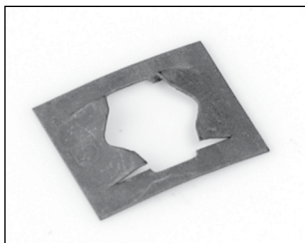

MARKING STRIPS

GB/GFT – Pre-punched black fiber mounts under block. May be imprinted to customer specifications.

To order, specify: Part No. 267A19-1 through 26 (with mounting hole); Part No. 267A218-1 through 26 (less mounting hole). (0882980XX)

COVERS (0191XX000 COVER + 019100000 CLIPS)

GB/GFT – Rigid .030" thick self-extinguishing vinyl. Black matte-finished on both sides. May double as marking strip when imprinted with white ink. Complete with spring clips for attaching to mounting positions.

Part No. 267B86-1 through 26 terminals

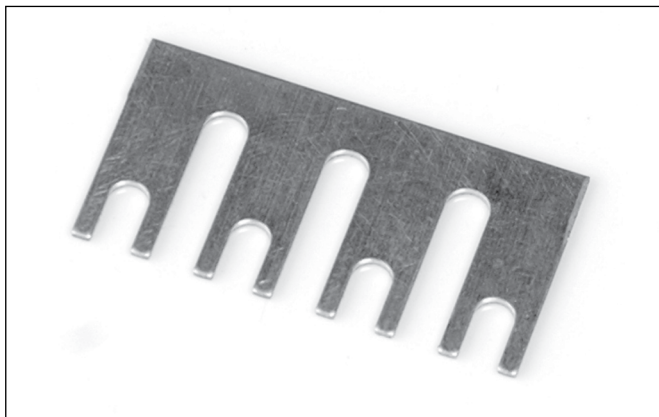
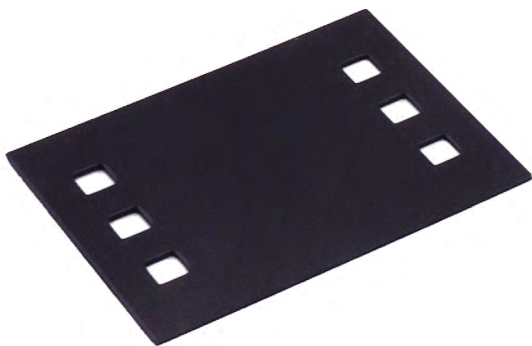

TERMINAL BLOCK JUMPERS

GB/GFT – Plated in two styles. Types 267A28 (080530100) is designed to jump two adjacent terminals as it is channeled to cross over the barrier top. "Rooster comb" design of Type 267A42 (0682106XX) permits connections of two to 18 poles. To order, specify: Part No. 267A42 (0682106XX) (plus no. of poles)

Example: 267A42-18 (0682106XX)